

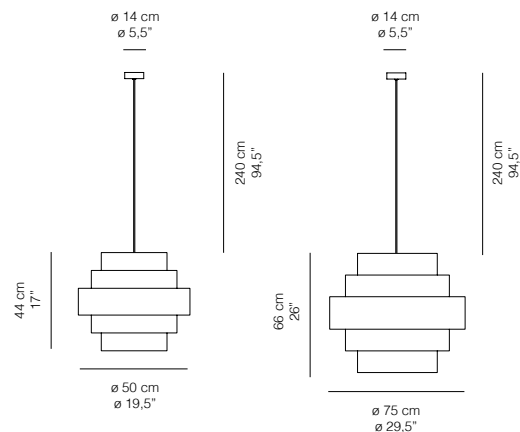









Lampada da sospensione costruita incastrando 96 volte sottilissimi fogli di tessuto bianco, rosso, nero. Rosone in metallo verniciato nero.

Suspended lamp made by slotting together 96 times very thin sheets of white, red, black textile fabric. Support in black-painted metal.



## SUN / Design Brian Rasmussen

		<b>Sospensione / Suspended</b>					
		<b>MISURE / DIMENSIONS</b>		<b>SORGENTI LUMINOSE / LIGHT SOURCES</b>			
		CM.	INCHES	FLUO	LED		
<b>SUN 50</b>		50ø x 44-240H	19,5ø x 17-94,5H	1x40W E27 	1x16W E27 		
<b>SUN 75</b>		75ø x 66-240H	29,5ø x 26-94,5H	3x20W E27 	3x10W E27 		
<b>SUN 50</b>		<b>COLORI / COLOURS</b>				<b>CERTIFICATIONS</b>	
05SPWH50S		Tessuto Bianco / White Textile fabric				  	
05SPRD50S		Tessuto Rosso / Red Textile fabric					
05SPBK50S		Tessuto Nero / Black Textile fabric					
<b>SUN 75</b>		<b>COLORI / COLOURS</b>				<b>CERTIFICATIONS</b>	
05SPWH75S		Tessuto Bianco / White Textile fabric				  	
05SPRD75S		Tessuto Rosso / Red Textile fabric					
05SPBK75S		Tessuto Nero / Black Textile fabric					
		<b>OPZIONI / OPTIONS</b>					
5MT		Sospensione cablaggio lunghezza cavi mt. 5,00 / Suspended with longer cables mt. 5,00					

05SPWH50S  
05SPWH75S



05SPBK50S  
05SPBK75S



05SPRD50S  
05SPRD75S

